

Operating Manual
Fast Diode Current Modulator VFS 05-50-U
10100548

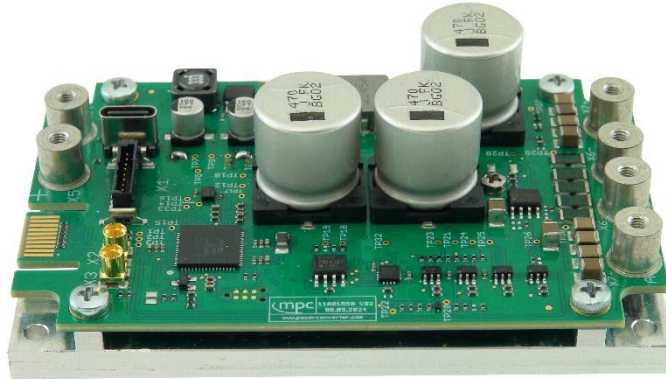

Index of contents	Page
General Description	3
Specification	4
Power Dissipation	5
Power Limits	6
Block Diagram	7
Signals and Data at the Interfaces	8
List of Error States	11
Initial Setup	12
Dimensioned Drawing	17
Ordering informations	17
Contact Data	17

General Description

The VFS driver is a linear current modulator that offers improved properties for driving current waveforms into laser diodes or LEDs.

It supports continuous (CW), pulsed, modulated, or mixed signal waveforms with frequencies up to 50 MHz and currents up to 5 A.

To operate the driver only one DC Power Supply is required.

The current setpoints can be defined via two analogue inputs and / or two software values.

It is also possible to use combinations of software and hardware setpoints.

The user can switch between Current Setpoint 1 and Current Setpoint 2 via an external trigger signal or an internal pulse generator.

Due to the high modulation speed and the parasitic inductances and capacitances of the laser diodes and LEDs, an individual tuning of the drivers control loop is required.

This tuning can be achieved by optimizing some software parameters.

Hardware modifications are not required in combination with most laser diodes and LEDs.

To achieve maximum performance, the driver should be mounted as close as possible to the laser diode and the connection should have an inductance as low as possible.

For this purpose, an additional stripline set is available (part number: 13000210).

Special stripline sets for special laser diodes or LEDs can also be delivered.

For detailed information and important hints, please contact our customer support.

Specification

Diode current	0 ... 5 A
Diode voltage	0 ... 44 V
Supply voltage	10 V ... 48 V, max. 50 V
Rise time	<10 ns (load dependent)
Fall time	<10 ns (load dependent)
Modulation (input 50 Ω)	0 ... 50 MHz max
Modulation (input 10 k Ω)	0 ... 100 kHz max
Onboard pulse generator	1 Hz ... 5 MHz
Pulse width	100 ns ... 1 s in steps of 10 ns

Inputs

Diode current set point 1	0 ... 1000 mV (input 50 Ω)
Diode current set point 2	0 ... 5 V (input 10 k Ω)
Trigger	TTL 5 V
Enable	TTL 5 V
Reset	TTL 5 V

Outputs

Diode current monitor	0 ... 250 mV (into 50 Ω)
Temperature	0 ... 4 V corresponds to 0 ... 80 $^{\circ}$ C
Ready	TTL 5 V
Error	TTL 5 V

Communication

USB interface	for configuration, controlling and monitoring
---------------	---

General specifications

Ambient temperature	0 ... +45 $^{\circ}$ C
Dimensions	95 mm x 60 mm x 30 mm
Weight	150 g

Power dissipation

The dynamic performance of the driver increases with the driver voltage, however the electrical power dissipation increases with the driver voltage too.

To find a compromise between efficiency and performance a driver voltage of 1 V ...5 V higher than the diode voltage is recommended.

Formulas for calculating max. power dissipation:

U_o Driver Voltage (V)
(generated by the internal DC-DC converter)

U_D Diode Voltage (V)
(diode voltage according to the data sheet)

I_{DCW} Diode Current CW (A)

I_{Dpeak} Diode Current peak value (A)
(for sinusoidal and rectangle currents)

I_{DMean} Diode Current Mean Value (A)

t_p Pulse Duration (s)

f Pulse Frequency (Hz)

P_L Power Dissipation (W)

Limits of maximum allowed power dissipations:

For operating with CW current or for pulse length >1ms:

$$P_L = (U_o - U_D) \cdot I_{DCW} < 30W$$

For operating with sinusoidal current:

$$P_L = (U_o - U_D) \cdot I_{Dpeak} < 30W$$

For operating with rectangle pulses with pulse length <1 ms:

$$P_{Lpulse} = (U_o - U_D) \cdot I_{Dpeak} < 50W$$

and

$$P_{Lmean} = (U_o - U_D) \cdot (I_{Dpeak} \cdot t_p \cdot f + I_{DCW}) < 30W$$

For operating with rectangle pulses with pulse length <100 μ s:

$$P_{Lpulse} = (U_o - U_D) \cdot I_{Dpeak} < 100W$$

and

$$P_{Lmean} = (U_o - U_D) \cdot (I_{Dpeak} \cdot t_p \cdot f + I_{DCW}) < 30W$$

The calculation of power dissipation with arbitrary current waveforms is rather difficult, therefore a good method for estimating power dissipation is to measure the temperature of the driver. The driver has a precise temperature measurement system inside.

Power limits

To protect the driver against too high power dissipation the power loss of the driver is monitored in three different ways:

Monitoring of the output stage temperature.

If the temperature exceeds 80 °C the driver will turn off the output stage. The current temperature can be monitored via the control software or through the serial interface.

Monitoring of the power dissipation mean value.

If the power dissipation exceeds 30 W for more than 1 second the driver will turn off the output stage. The current power dissipation can be monitored via the control software or through the serial interface.

High speed monitoring of the power dissipation.

If the power dissipation exceeds 50 W for more than 1 ms the driver will turn off the output stage.

If the power dissipation exceeds 100 W for more than 36 µs the module will turn off the output stage.

General instructions

Never run the driver with a negative current setpoint, this can lead to unwanted current outputs and may destroy diodes.

If you use a pulse signal generator or a function generator for the current set point, always disconnect it before you change any ranges. Some generators create high voltages or undefined signals if you change ranges, this may destroy diodes and the driver.

Indicator elements

Green LED:

The LED is blinking if the driver is ready and there are no errors.

Yellow LED:

The LED is blinking if one of the monitored values exceeds the warning level.

The preconfigured warning levels can be changed through the serial interface or by using the MPC GUI software. Warnings do not have any influence to the driver function.

Warnings just monitor that the driver is operating near to an error.

Red LED:

The LED is blinking if the driver is disabled due to overtemperature or if another fault occurs.

The fault can be checked via the serial interface or by MPC GUI software.

See chapter 6 for a list of error codes.

The driver will stop operation until the fault is cleared and a reset signal is sent to the driver.

This can be done via the serial interface or by a hardware reset at pin 4 of X1.

Block diagram

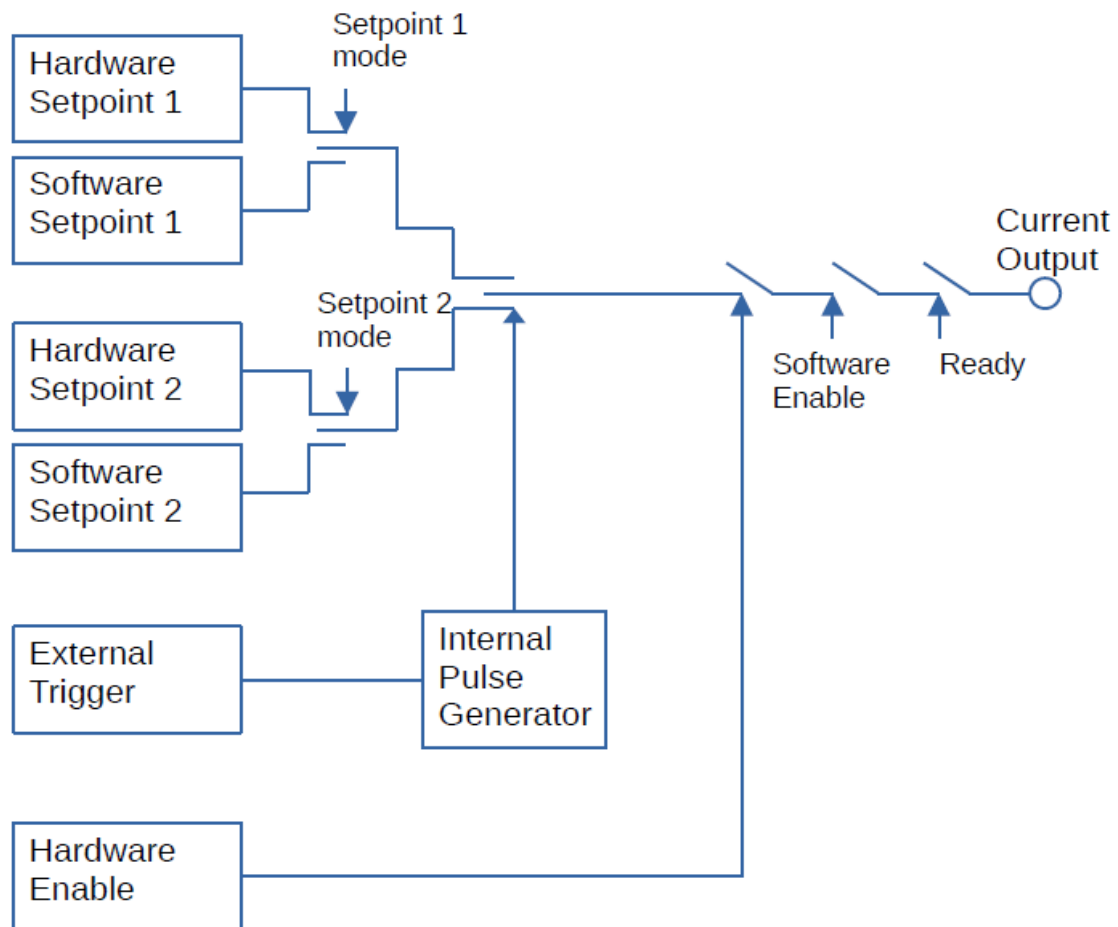

Connectors

- X1 8-pole single row male connector for control signals and status signals
- X2 Female coaxial jack MMCX for diode current setpoint 1
- X3 Female coaxial jack MMCX for actual diode current
- X4 Screw terminal with female thread M3 for supply voltage Ground
- X5 Screw terminal with female thread M3 for supply voltage V+
- X6 Two screw terminals with female thread M3 for diode cathode
- X7 Two screw terminals with female thread M3 for diode anode
- X8 USB 3.1 Type C connector for USB communication

Signals and data at the interfaces

Definition of terms

CA = Control Data Analog
 CD = Control Data Digital
 SA = Status Data Analog
 SD = Status Data Digital

X1 Control Port

8-pole single row male connector
 Manufacturer: ERNI Part number 214014
 Mating Plug:
 8-pole single row female connector
 Manufacturer: ERNI Part number 224396



Inputs		
Pin	Name	Function
1	GND	Signal Ground
2	CA-DCSP2	Diode Current Setpoint 2
3	CD-ENABLE	Enable
4	CD-RESET	Reset
7	CD-TRIGGER	Trigger Setpoints
Outputs		
Pin	Name	Function
1	GND	Signal Ground
5	SA-TEMP	Temperature
6	SD-READY	Ready
8	SD-ERROR	Error

X2 Control Port

Female coaxial jack MMCX

CA-DCSP1

Diode Current Setpoint 1

X3 Current Monitor Port

Female coaxial jack MMCX

SD-DCACT

Diode Current Actual

X4 V- Supply

Supply Voltage Minus
Screw terminal with female thread M3, thread depth 4 mm
Tightening torque 0.5 Nm

X5 V+ Supply

Supply Voltage Plus
Screw terminal with female thread M3, thread depth 4 mm
Tightening torque 0.5 Nm

X6 Diode Cathode

Diode Cathode
Screw terminal with female thread M3, thread depth 4 mm
Tightening torque 0.5 Nm

X7 Diode Anode

Diode Anode
Screw terminal with female thread M3, thread depth 4 mm
Tightening torque 0.5 Nm

X8 Serial Port

Serial Communication
USB 3.1 Type C connector for USB communication

Signal Description**X4 V- Supply and X5 V+ Supply**

Supply voltage for the driver.
The supply voltage must be higher than the diode voltage.
Recommended values are approximately 8 ... 10 V above the diode voltage.
Minus must be connected at X4, Plus must be connected at X5.

CA-DCSP1 (X2)

Control Analog – Diode Current Setpoint 1
Analogue input 0 ... 1000 mV
Input impedance 50 Ohm
0 ... 1000 mV corresponds to a diode current of 0 ... 5 A

CA-DCSP2 (X1-2)

Control Analog – Diode Current Setpoint 2
Analogue input 0 ... 5 V
Input impedance 10 kOhm
0 ... 5 V corresponds to a diode current of 0 ... 5 A

SA-DCACT (X3)

Status Analog – Diode Current Actual
Analogue output 0 ... 500 mV (off-load voltage), reflects the actual diode current
Output impedance 50 Ohm

0 ... 500 mV corresponds to a diode current of 0 ... 5 A

For maximum dynamic performance the coaxial cable should be terminated with 50 Ohm.

In this case 0 ... 250 mV corresponds to a diode current of 0 ... 5 A

SA-TEMP (X1-5)

Status Analog – Temperature

Analogue output 0 ... 4 V, reflects the actual temperature of the driver

0 ... 4 V corresponds to 0 ... +80 °C

CD-ENABLE (X1-3)

Control Digital – Enable

Digital TTL input, High if left open

A Low-signal or pulling the input to GND enables the diode current

CD-RESET (X1-4)

Control Digital – Reset

Digital TTL input, High if left open

A Low-signal or pulling the input to GND resets the driver if there was an error

CD-TRIGGER (X1-7)

Control Digital – Trigger

Digital TTL input

The trigger signal switches between Diode Current Setpoint 1 (CA-DCSP1) und Diode Current Setpoint 2 (CA-DCSP2)

If CD-TRIGGER is High, then Diode Current Setpoint 1 (CA-DCSP1) is active

If CD-TRIGGER is Low, then Diode Current Setpoint 2 (CA-DCSP2) is active

SD-READY (X1-6)

Status Digital – Ready

Digital TTL output, High if there are no errors

SD-ERROR (X1-8)

Status Digital – Error

Digital TTL output, High if an error occurs

List of Error States

If an error occurs the red LED on the driver blinks.

In this case the signal SD-READY will switch to a low status and the signal SD-ERROR will switch to a high status.

To analyze the source of the error the serial command "GET ERROR STATE" or the MPC GUI Software can be used.

Error	Description	Action
V INPUT HIGH	Supply voltage is too high	Reduce and check supply voltage at X4 and X5 and reset the driver
V INPUT LOW	Supply voltage is too low.	Increase and check input voltage at X4 and X5 and reset the driver
OVERTEMPERATURE	Temperature of the driver is too high	Check power dissipation or improve cooling of the driver
POWER LOSS HIGH 1	Power dissipation within 36 μ s is too high	Check CA-DCSP1 and CA-DCSP2 Check configuration of the onboard pulse generator
POWER LOSS HIGH 2	Power dissipation within 1ms is too high	Check CA-DCSP1 and CA-DCSP2 Check configuration of the onboard pulse generator
POWER LOSS HIGH 3	Power dissipation within 1s is too high	Check CA-DCSP1 and CA-DCSP2 Check configuration of the onboard pulse generator
OUTPUT CURRENT	Output current is higher than 12 A	Check CA-DCSP1 and CA-DCSP2 Reset the driver, if error persists contact MPC for support
SENSOR	Fault in the internal temperature sensor	Check cabling, reset the driver, if error persists contact MPC for support
MOSFET	Output Mosfet is defective	Reset the driver, if error persists contact MPC for Support
V 6	+6 volt onboard is not correct	Check cabling, reset the driver, if error persists contact MPC for Support
V MINUS 6	- 6 volt onboard is not correct	Check cabling, reset the driver, if error persists contact MPC for Support
V DIODE HIGH	Diode voltage at internal DC-DC Converter output is higher than configured	Check cabling, reset the driver, if error persists contact MPC for Support
V DIODE LOW	Diode voltage at internal DC-DC Converter output is lower than configured	Check cabling, reset the driver, if error persists contact MPC for Support
V DIODE	Fault in the internal DC-DC Converter	Reset the driver, if error persists contact MPC for Support

Initial setup

For the initial setup of the driver, it is recommended to use the MPC GUI software.
To understand the concept and operation of the software, please see the latest documentation.
Part number of GUI Software documentation: 31000057

The following steps explain how to setup an unconfigured driver.
If you ordered a driver with a special adaptation to your diode all parameters especially Diode Param 1 and Diode Param 2, are pre-set by MPC.

Precaution procedures

- Avoid static discharge from personnel!
- Switch off the DC power supply for the driver!
- The diode must be mounted electrically isolated!
- Neither the cathode nor the anode of the diode may be grounded!

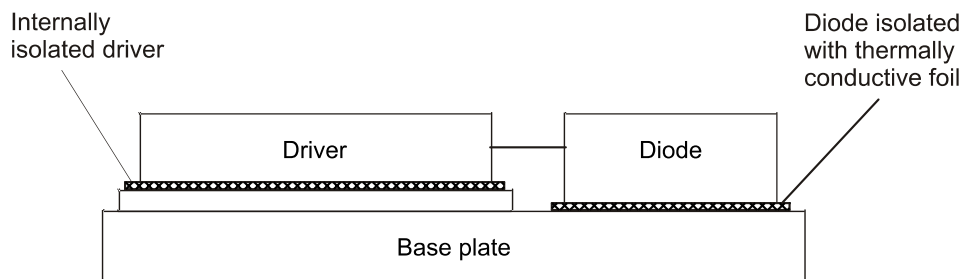

Procedure

1. Install MPC GUI software.
2. Connect a USB-C cable between the driver and the computer.
3. Connect a DC power supply to the driver.
4. Connect X3 to an oscilloscope with an input impedance of 50 Ohm.
5. Apply a low-inductance short circuit at the driver output, as illustrated in the following two example images.

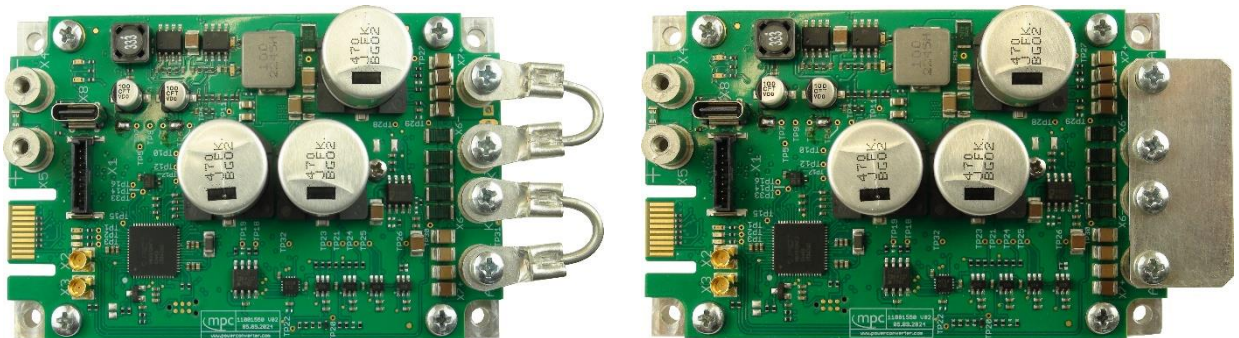

6. Turn on the DC power supply, run the MPC GUI software and connect the driver.
7. Ensure that HW Enable ist set to "Disable" and Enable Mode is set to "Software".

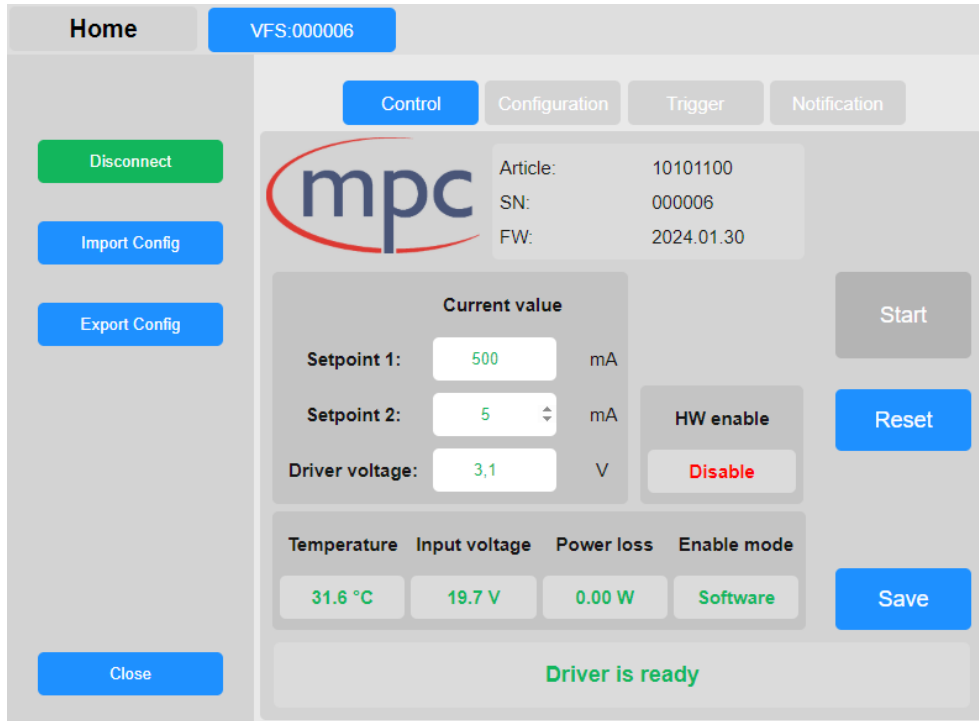

8. Navigate to the Configuration Tab and make the settings as shown in the following image.

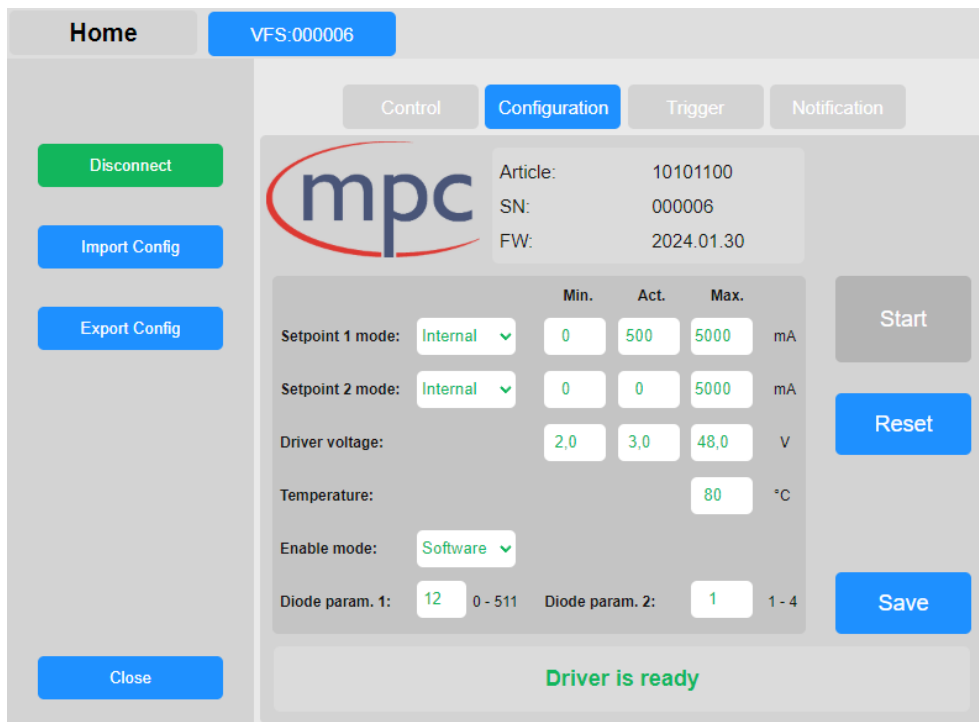

9. Navigate to the Trigger Tab and make the settings as shown in the following image.

The screenshot shows the MPC web interface with the 'Trigger' tab selected. The interface includes a sidebar with 'Disconnect', 'Import Config', 'Export Config', and 'Close' buttons. The main area displays the MPC logo and device information: Article: 10101100, SN: 000006, FW: 2024.01.30. The configuration section is set to 'Internal Pulse generator' mode. The 'Pulse unit' is 'Pulse length & Pulse period'. The 'Pulse length' is 5.00 us and the 'Pulse period' is 100.00 us. The 'Burst pause' is ns and the 'Num. of pulses' is 1-1000. There are 'Start', 'Reset', and 'Save' buttons. A status bar at the bottom indicates 'Driver is ready'.

10. Connect the CD-Enable pin at X1 to GND to activate the driver.

The screenshot shows the MPC web interface with the 'Control' tab selected. The interface includes a sidebar with 'Disconnect', 'Import Config', 'Export Config', and 'Close' buttons. The main area displays the MPC logo and device information: Article: 10101100, SN: 000006, FW: 2024.01.30. The configuration section shows 'Current value' with 'Setpoint 1' at 500 mA and 'Setpoint 2' at 0 mA. The 'Driver voltage' is 3.1 V. There is an 'HW enable' section with an 'Enable' button. A status bar at the bottom indicates 'Driver is ready'.

11. Press the Start Button to generate output current.

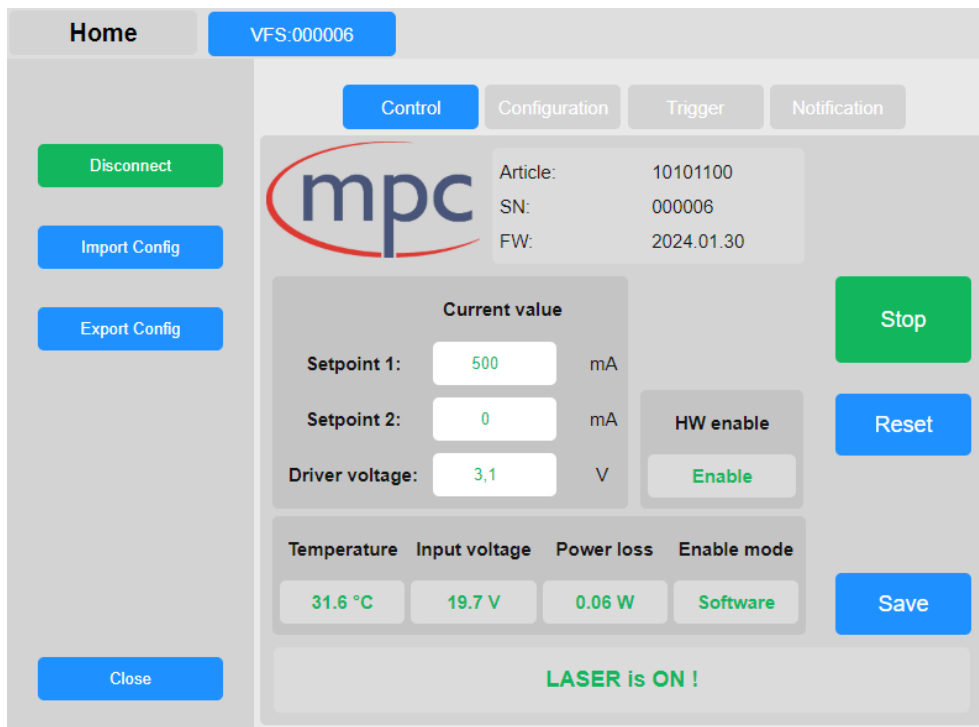

12. Verify the X3 signal on the oscilloscope.

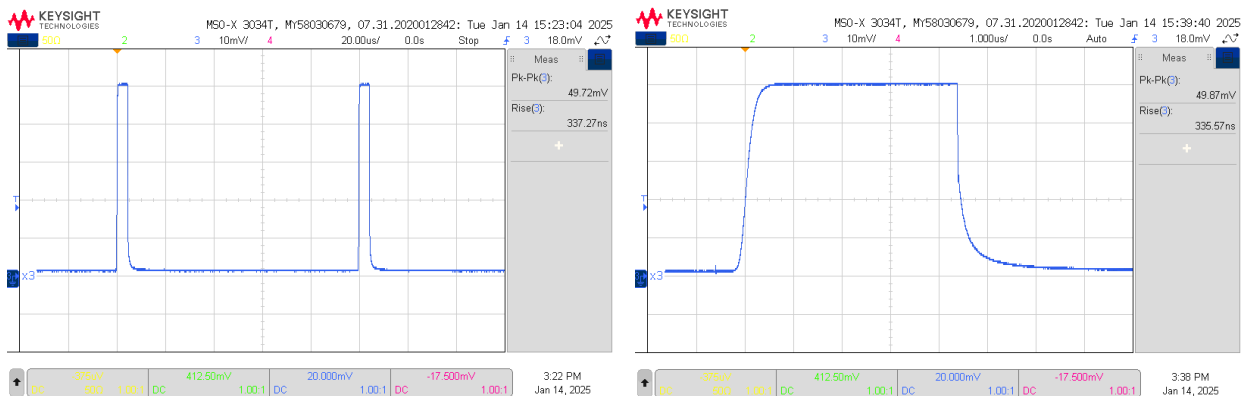

13. Press the Stop Button to turn off the driver.
14. Turn off the DC power supply.
15. Remove the connection between the CD-Enable pin at X1 and GND.
16. Remove the short circuit at the driver output.

17. Connect the diode at the driver output.

Caution!

Pay attention to Laser Safety.

In the following steps, laser light may be emitted.

18. Turn on the DC power supply.

19. Set Setpoint 1 to 5-20% of maximum diode current.
Set Setpoint 2 to 10% below diode threshold current.
Set driver Voltage to 1 ... 5 V above diode voltage.
Set values for pulse length and pulse duration that are typical for your final application.
It is recommended to start with pulse lengths shorter than 50 μ s and duty cycles of less than 10%, preferable 1%.

20. Optimize Diode Param 1 and Diode Param 2 in Configuration Mode.
Increasing Diode Param 1 will increase risetime of the diode current.
Increasing Diode Param 2 will help to reduce overshoot at risetimes $>200 \mu$ s.

21. After optimizing Diode Param 1 and Diode Param 2, the system is ready for individual configurations and can operate with arbitrary external setpoints or trigger signals instead of the onboard pulse generator.

Dimensioned drawing (mm)

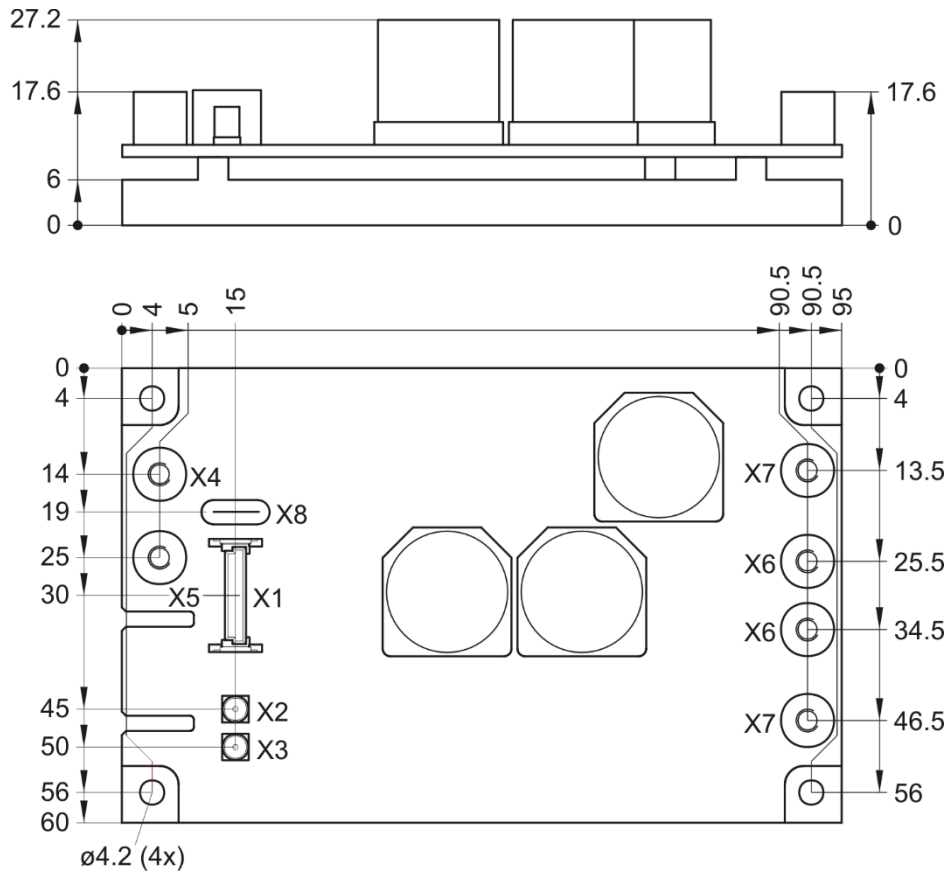

Ordering Codes

VFS 05-50-U	10100548
USB Cable USB C to SubD9M 0.25 m	11002352
USB Cable USB C to USB A 0.5 m	11002351
MPC GUI software for PC	31000057

Contact Data

MESSTEC Power Converter GmbH
Grube 41
D-82377 Penzberg
Phone +49 (0) 8856-80306-0
info@powerconverter.com
www.powerconverter.com

Technical subjects to change without notice